

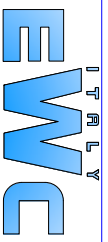

Item	CHARACTERISTICS	Unit	EWC-T-D-O-1000-0000
1	<b>Manufacturer</b>		<b>EWC</b>
2	<b>Rated power ONAN</b>	<b>kVA</b>	<b>1000</b>
3	Rated frequency	Hz	50
4	Rated. MV wind. voltage	kV	11
5	Steps of regulation on the MV side off-load	%	± 2 x 2,5
6	Rated LV wind. Voltage No-load	kV	0,416
7	MV/LV wind. connections		Delta/star+N
8	Vector group		Dyn11
9	Max altitude on the sea level	m	1000
10	Min. ambient temperature	°C	-5
11	Max ambient temperature	°C	55
12	Average yearly ambient temperature	°C	30
13	Type of installation		outdoor
14	Type of cooling		ONAN
15	Dielectric oil		MINERAL
16	Construction standards		IEC 60076-IEC60354
17	Isolation class of MV windings	kV	12/28/75
18	Isolation class of LV windings	kV	1,1/3
18.1	Winding insulation		Uniform
19	Thermal class of isolement		A
20	Average temp rise of HV/MV windings	°C	50
21	Max temp rise of oil	°C	45
22	No-load losses to Vn	W	1300
23	No-load current to Vn/110% Vn	%	0.9
24	Load-losses ref. To 75°C	W	10500
25	Impedance ref. To 75°C	%	6.0
26	Sound Power level	dB(A)	63
27	Efficiency		
	100% Pn cos φ= 1	%	98.82
	75% Pn cos φ= 1	%	99.04
	50% Pn cos φ= 1	%	99.22
28	Weight of magnetic core	Kg	852
29	Wind. weight	Kg	480
30	Dielectric oil weight	Kg	475
31	Total weight	Kg	2600
32	Dimensions: in plant (LxP)	mm	1800x1200
	Height (H)	mm	1650
	Interdistance of wheels (IR)	mm	820
33	Painting colour		RAL 7031

#### Fittings and Accessories:

- Terminal marking plate.
- Tapping switch.
- Valves 3 / 4 B.S.P fitted on cover and bottom of tank, switch cocks.
- Thermometer pocket with thermometer including max. temp. measurement indicator with two separate free contacts.
- Lifting lugs.
- Pressure relief valve.
- Earthing terminal on tank.
- Rating and diagram plate to be chromium plated of the engraved type with KVA rating and serial number engraved inside the transformer at a suitable place.
- Skid mounting to be vertical with the length of the transformer.
- Oil level indicator, to be of mechanical type located on the top cover of transformer to avoid oil leakage, covered by metallic Envelop.

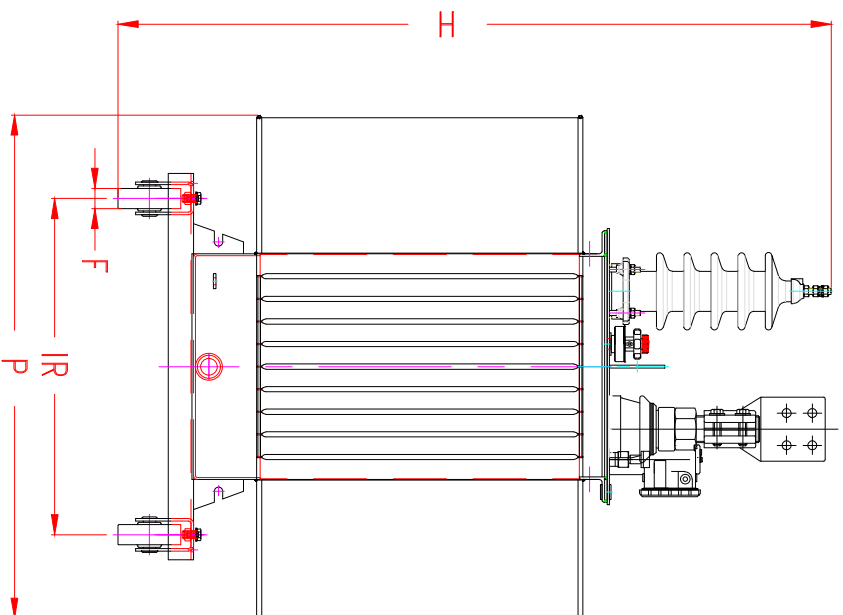
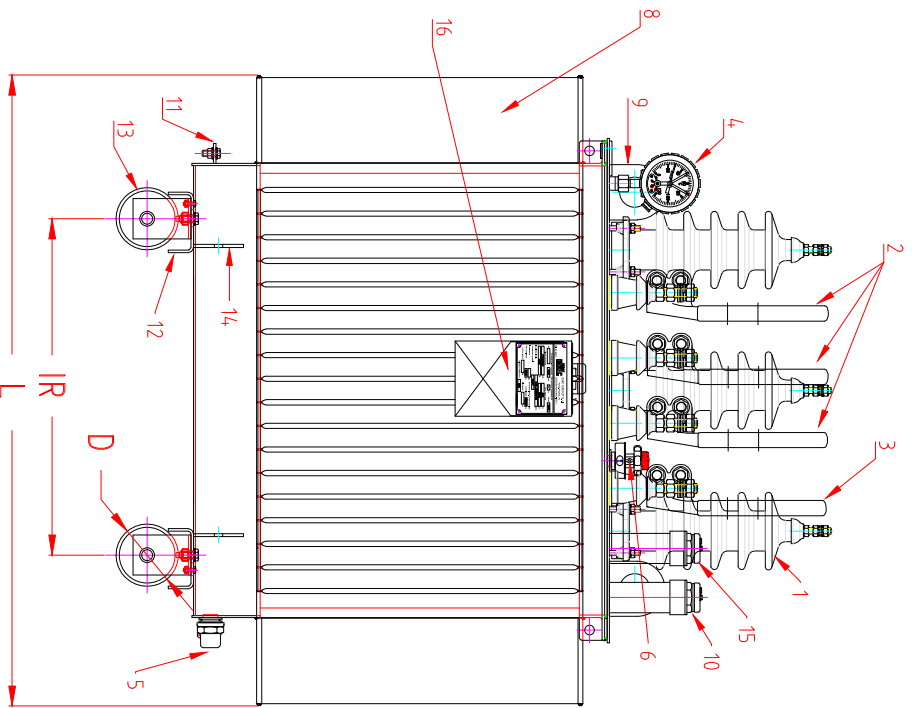

REGIONE	00	EMISSIONE	T. AL-SALHI	T. AL-SALHI	T. AL-SALHI
REGIONE		DESCRIZIONE	ELABORATO	CONTROLLATO	APPROVATO
DATA		DESCRIZIONE	MODIFICATO	REVISIONE	APPROVATO

CLIENTE  
**EWC GROUP srl**

TITOLO	Distribution	COMMESSA
TRANSFORMER /	0000 KVA - 11/0,415KV	FILE
TRANSFORMAZIONE DI DISTRIBUZIONE		FILE
DESIGN		DESIGN
FOGLIO		FOGLIO
1		1
DI		DI
2		2

A TORNARE IN LEGGE DI RESERVAZIONE LA PROPRIETA' IN QUESTO DISEGNO CON DIRITTO DI RIPRODUZIONE O DI RENDIMENTO COMUNALE, TUTTO A TORNARE O A TUTTE LE CONDIZIONI SENZA NESSUNA AUTORIZZAZIONE. COMPRESO DI TUTTI I DIRITTI DI RESERVAZIONE, ASSISTENZA E DI TUTTI I DIRITTI DI RESERVAZIONE. COMPRESO DI TUTTI I DIRITTI DI RESERVAZIONE, ASSISTENZA E DI TUTTI I DIRITTI DI RESERVAZIONE.

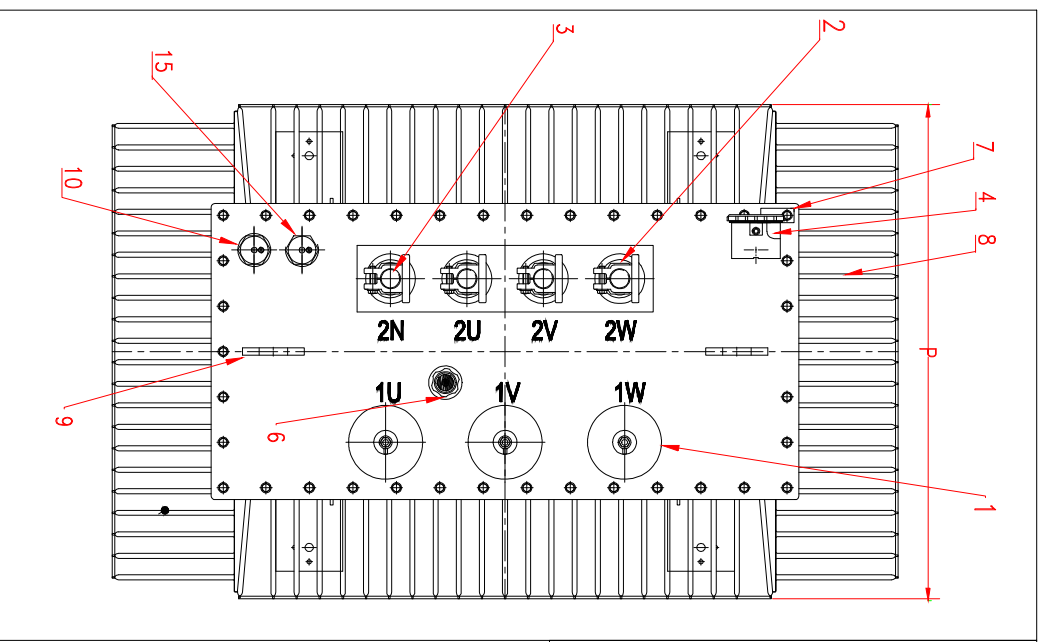

Pos.1 – No scdia

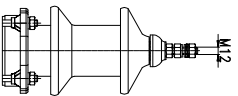

M.T. Isolatore passante  
in porcellana 12kV/250A  
-----  
H.V. Bushing Insulating  
in porcelain 12kV/250A

Pos.2-3 – No scdia

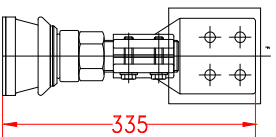

Isolatore BT passante in  
porcellana 1kV/2000A  
-----  
LV Bushing insulating  
in porcelain 1kV/2000A

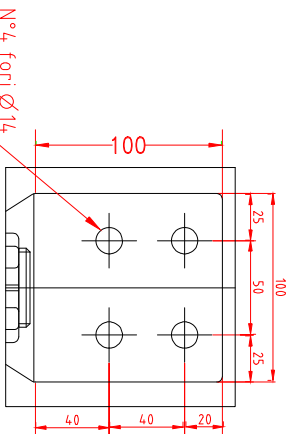

Description / Descrizione	
Raffreddamento / Cooling	ONAN
Potenza / Power	0000 KVA
Tensioni / Voltage	11/0.4/16 kV
Gruppo / Connection Sym.	Dyn11
Frequenza / Frequency	50 Hz
Peso Olio / Oil weight	
Peso Totale / Total weight	

Pos.	Description / Description	N°
1	Isolatori M.T. 1U 1V 1W / H.V. Bushing 1U 1V 1W	3
2	Isolatori B.T. 2U 2V 2W / L.V. Bushing 2U 2V 2W	3
3	Isolatore Neutro 2N / Neutral Bushing 2N	1
4	Termometro Olio / Oil Thermometer	1
5	Valvola di scarico olio / Oil drain valve	1
6	Manopola commutatore / Tap changer knob	1
7	Piastrina per matricola / Platelet for matriculation	1
8	Pannello radiante / Radiator panels	4
9	Golfari di sollevamento / Lifting lugs	2
10	Valvola di sovrappressione / Over pressure valve	1
11	Morsetto di messa a terra / Earthing clamp	2
12	Base di appoggio / Base cart	2
13	Ruote orientabili / Wheels orientable	4
14	Ganci di trainto / Towing hooks	4
15	Indicatore di livello olio / Oil level gauge	1
16	Targa caratteristiche / Rating plate	1

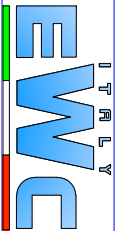

REVISIONE	DATA	EMMISSIONE	ELABORATO	CONTROLLO	APPROVATO
00			T. AL-SALHI	T. AL-SALHI	T. AL-SALHI

EWC GROUP SRI

CALORE	COMMEDIA
000000000000	000000000000

TITOLO: **Distribution Transformer / Transformatore di distribuzione**  
0000 KVA - 11/0.4/16kV

DISEGNO: FOGLIO 2 DI 2

A FIRMARE IN LEGGE DI REGISTRAZIONE IL DOCUMENTO IN CASO DI RESISTENZA, CON SUOI CONTENUTI, E' RICHIESTA LA PRESENTAZIONE DELLA FIRMA E LA DATA DI FIRMA. IL DOCUMENTO IN CASO DI RESISTENZA, CON SUOI CONTENUTI, E' RICHIESTA LA PRESENTAZIONE DELLA FIRMA E LA DATA DI FIRMA. IL DOCUMENTO IN CASO DI RESISTENZA, CON SUOI CONTENUTI, E' RICHIESTA LA PRESENTAZIONE DELLA FIRMA E LA DATA DI FIRMA. IL DOCUMENTO IN CASO DI RESISTENZA, CON SUOI CONTENUTI, E' RICHIESTA LA PRESENTAZIONE DELLA FIRMA E LA DATA DI FIRMA. IL DOCUMENTO IN CASO DI RESISTENZA, CON SUOI CONTENUTI, E' RICHIESTA LA PRESENTAZIONE DELLA FIRMA E LA DATA DI FIRMA.